

PCB terminal block - PTSM 0,5/ 7-2,5-H THR WH R32 - 1814540

Please be informed that the data shown in this PDF Document is generated from our Online Catalog. Please find the complete data in the user's documentation. Our General Terms of Use for Downloads are valid (<http://phoenixcontact.com/download>)



PCB terminal block, nominal current: 6 A, rated voltage (III/2): 160 V, nominal cross section: 0.5 mm², number of potentials: 7, Number of rows: 1, Number of positions per row: 7, product range: PTSM 0,5/..-H-THR WH, pitch: 2.5 mm, connection method: Push-in spring connection, mounting: THR soldering, conductor/PCB connection direction: 0 °, color: white, Pin layout: Linear double pinning, Solder pin [P]: 2.1 mm, type of packaging: 32 mm wide tape

The figure shows the 3-pos. version

Your advantages

- ✓ White design: Stable color when welding and during use
- ✓ Time saving push-in connection, tools not required
- ✓ Defined contact force ensures that contact remains stable over the long term
- ✓ High current carrying capacity of 6 A in very compact dimensions
- ✓ Designed for integration into the SMT soldering process



Key Commercial Data

Packing unit	1 pc
Minimum order quantity	530 pc
GTIN	
GTIN	4046356760294
Weight per Piece (excluding packing)	2.230 g
Custom tariff number	85369010
Country of origin	India

Technical data

Item properties

Brief article description	PCB terminal block
Range of articles	PTSM 0,5/..-H-THR WH
Pitch	2.5 mm

PCB terminal block - PTSM 0,5/ 7-2,5-H THR WH R32 - 1814540

Technical data

Item properties

Number of positions	7
Mounting type	THR soldering
Pin layout	Linear double pinning
Number of levels	1
Number of connections	7
Number of potentials	7

Electrical parameters

Nominal current	6 A
Nom. voltage	160 V
Rated voltage (III/3)	160 V
Rated voltage (III/2)	160 V
Rated voltage (II/2)	400 V
Rated surge voltage (III/3)	2.5 kV
Rated surge voltage (III/2)	2.5 kV
Rated surge voltage (II/2)	2.5 kV

Connection capacity

Connection method	Push-in spring connection
pluggable	no
Conductor cross section solid	0.14 mm ² ... 0.5 mm ²
Conductor cross section flexible	0.2 mm ² ... 0.5 mm ² (up to 0.75 mm ² supported, at a rated insulation voltage of 32 V at III/2)
Conductor cross section AWG / kcmil	26 ... 20
Conductor cross section flexible, with ferrule without plastic sleeve	0.25 mm ² ... 0.5 mm ²
Conductor cross section, flexible, with ferrule, with plastic sleeve	0.25 mm ² ... 0.34 mm ²
Stripping length	6 mm

Material data - contact

Note	WEEE/RoHS-compliant, free of whiskers according to IEC 60068-2-82/ JEDEC JESD 201
Contact material	Cu alloy
Surface characteristics	hot-dip tin-plated
Metal surface terminal point (top layer)	Tin (4 - 8 µm Sn)
Metal surface soldering area (top layer)	Tin (4 - 8 µm Sn)

Material data - housing

Housing color	white (9010)
Insulating material	PA
Insulating material group	I

PCB terminal block - PTSM 0,5/ 7-2,5-H THR WH R32 - 1814540

Technical data

Material data - housing

CTI according to IEC 60112	600
Flammability rating according to UL 94	V0

Dimensions for the product

Caption	Schematische Abbildung - weitere Details siehe Produktfamilienzeichnung im Download Center
Length [l]	10 mm
Width [w]	18 mm
Height [h]	7.1 mm
Pitch	2.5 mm
Height (without solder pin)	5 mm
Solder pin [P]	2.1 mm
Pin spacing	2.5 mm
Pin dimensions	0.3 x 0.8 mm

Dimensions for PCB design

Hole diameter	1.2 mm
Pin spacing	2.5 mm

Packaging information

Type of packaging	32 mm wide tape
Pieces per package	530
Denomination packing units	Pcs.
[W] tape width	32 mm
[A] coil diameter	330 mm
[W2] coil overall dimension	38.4 mm
Outer packaging type	Transparent-Bag
ESD level	(D) electrostatically conductive
Specification	DIN EN 61340-5-1 (VDE 0300-5-1): 2008-07

Processing notes

Process	Reflow/wave soldering
Specification	Following IPC/JEDEC J-STD-020D.1:2008-03
	Following IEC 61760-1:2006-04
	Following IEC 60068-2-58:2005-02
Moisture Sensitive Level	MSL 1
Classification temperature T _c	260 °C
Solder cycles in the reflow	3

Electrical tests

PCB terminal block - PTSM 0,5/ 7-2,5-H THR WH R32 - 1814540

Technical data

Electrical tests

Rated current	6 A
Conductor cross section	0.5 mm ²
Rated voltage (III/2)	160 V
Rated surge voltage (III/2)	2.5 kV

Air clearances and creepage distances

Standards and Regulations

Connection in acc. with standard	EN-VDE
	UL
Flammability rating according to UL 94	V0

Environmental Product Compliance

China RoHS	Environmentally friendly use period: unlimited = EFUP-e
	No hazardous substances above threshold values

Drawings

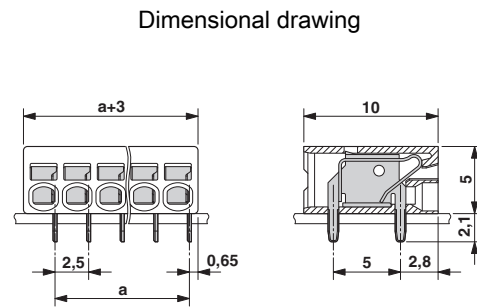
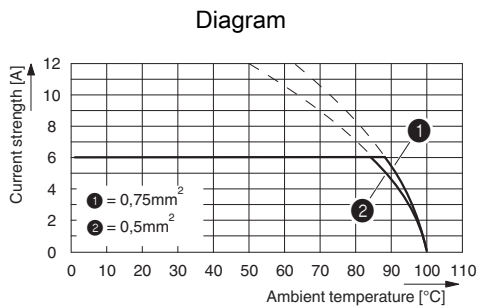

Type: PTSM 0,5/...-2,5-H- THR R...
 Tested in accordance with DIN EN 60512-5-2:2003-01
 Reduction factor = 1
 No. of positions: 5

Classifications

eCl@ss

eCl@ss 10.0.1	27440401
eCl@ss 11.0	27460101
eCl@ss 4.0	27141100
eCl@ss 4.1	27141100
eCl@ss 5.0	27141100
eCl@ss 5.1	27261100

PCB terminal block - PTSM 0,5/ 7-2,5-H THR WH R32 - 1814540

Classifications

eCl@ss

eCl@ss 6.0	27261100
eCl@ss 7.0	27440401
eCl@ss 9.0	27440401

ETIM

ETIM 3.0	EC001121
ETIM 4.0	EC002643
ETIM 6.0	EC002643
ETIM 7.0	EC002643

UNSPSC

UNSPSC 6.01	30211801
UNSPSC 7.0901	39121432
UNSPSC 11	39121432
UNSPSC 12.01	39121432
UNSPSC 13.2	39121432
UNSPSC 18.0	39121432
UNSPSC 19.0	39121432
UNSPSC 20.0	39121432
UNSPSC 21.0	39121432

Approvals

Approvals

Approvals

VDE Zeichengenehmigung / UL Recognized / EAC / cULus Recognized

Ex Approvals

Approval details

VDE Zeichengenehmigung		http://www2.vde.com/de/Institut/Online-Service/VDE-gepruefteProdukte/Seiten/Online-Suche.aspx	40048725
------------------------	--	---	----------

PCB terminal block - PTSM 0,5/ 7-2,5-H THR WH R32 - 1814540

Approvals

UL Recognized		http://database.ul.com/cgi-bin/XYV/template/LISEXT/1FRAME/index.htm	E118976-20130619
			B
Nominal voltage UN			150 V
Nominal current IN			5 A
mm ² /AWG/kcmil			26-18

EAC			B.01687
-----	--	--	---------

cULus Recognized		http://database.ul.com/cgi-bin/XYV/template/LISEXT/1FRAME/index.htm	E60425-20030527
			B
Nominal voltage UN			150 V
Nominal current IN			5 A
mm ² /AWG/kcmil			26-20

Accessories

Accessories

Cable end sleeve

Ferrule - AI 0,25- 6 BU - 3203040



Ferrule, sleeve length: 6 mm, length: 10.5 mm, color: blue

Ferrule - AI 0,25- 6 YE - 3203024



Ferrule, sleeve length: 6 mm, length: 10.5 mm, color: yellow

PCB terminal block - PTSM 0,5/ 7-2,5-H THR WH R32 - 1814540

Accessories

Ferrule - AI 0,34- 6 TQ - 3203053



Ferrule, sleeve length: 6 mm, length: 10.5 mm, color: turquoise

Screwdriver tools

Screwdriver - SZS 0,4X2,0 - 1205202



Micro screwdriver, bladed, size: 0.4 x 2.0 x 60 mm, 2-component grip, with non-slip grip and twist cap

Additional products

Sample set - SAMPLE PTSM 0,5/ 7-2,5-H-THR - 1701098



PCB terminal block, nominal current: 6 A, rated voltage (III/2): 160 V, nominal cross section: 0.5 mm², number of potentials: 7, Number of rows: 1, Number of positions per row: 7, product range: PTSM 0,5/..-H-THR, pitch: 2.5 mm, connection method: Push-in spring connection, mounting: THR soldering, conductor/PCB connection direction: 0 °, color: black, Pin layout: Linear double pinning, Solder pin [P]: 2.1 mm, type of packaging: packed in cardboard. SAMPLE set with 5 items in belt section. When used as part of soldering process, please use items without SAMPLE marking